

The ARTPLASTICS Tribune

Special Exhibition Edition ■ Volume1 / Issue1 ■ June 4th 2007 Australia ■ Products ■ News ■ Advertisement ■

“I screwed Paris Hilton” claims John Howard

Clark Kent
Central Plumbing Agency

Sydney plumber John Howard says he was recently overcharged for the minibar during his stay in France, when he failed to get satisfaction from the management he knew one good way to get some payback. Just like when people in Sydney who don't pay their plumbers get their "backup", a few missing towels later and long after John had left the country the Paris Hilton's plumbing system was well and truly screwed.

Space Maker satisfies Katrina

Tim Lucas
Chief Product Analyst

Her name was Katrina, she seemed nice but her voice was soon to haunt all tradesmen who had worked on the job. Stuck at home she had little else to do but seek out the smallest of flaws ... she demanded more under sink space!

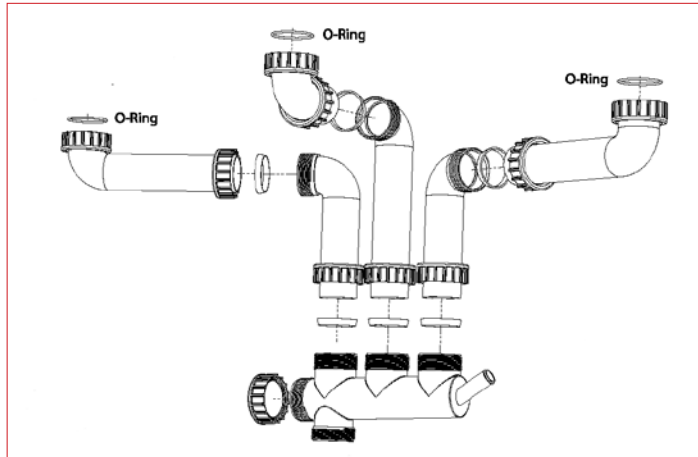

The hard facts

- The average kitchen in a new home is 30% smaller making under sink storage a necessity.
- The Art Plastics Space Maker frees up valuable under sink space and is easy to install.
- Adds value to any home.

The new Space Maker from Art Plastics came to the rescue! The Space Maker creates more room under the sink by getting the waste assembly up against the back of the cabinet, especially useful when a gas unit is also located inside the sink cabinet. The Space Maker can connect up to three bowls and adjusts in height and offset. Truly a space maker! Katrina was well pleased and loved its stylish silver appearance.



Plumber's apprentice of the month.....page 3

Breaking News:

MEGAFLEX has taken the Australian market by storm. "No more chipping" page..... 3



Inside this issue:

- Space Maker.....page 1
- Mizu Long Grates.....page 2
- Megaflex.....page 3
- Rainwater Heads.....page 4
- Classic Downpipe.....page 5
- Classified Ads.....page 6
- Distributors.....page 8

Development

Art Plastics' development team has commenced testing a range of new products that will revolutionise the plumbing industry. Visit www.artplastics.com.au

The Mystery of the Bermuda Grate

David Doerfer
Central Plumbing Agency



"Where does the water go?" Many people ask the same question and with the current water crisis it is reassuring to know that it is not disappearing at all. The water escapes past the tile insert where it then flows through the brass waste body to join the waste pipes just like a normal floor grate.



"Advertisements contain the only truths to be relied upon in a newspaper"

It's all about Water: The Mizu Long Grate

Scott Johnstone

Chief Development Engineer

The Mizu Shower Channel is the stylish new long grate designed to complement modern bathrooms. Channel grates are popular in line with



the trend to larger tiles, including porcelain, that are best laid in one plane to gain adequate falls. Traditional shower channels require complex and costly custom installation. The Watermark approved Mizu Shower Channel changes all this with its one piece body and associated Mega flex adaptor, ensuring installations that perform as well as they look! The Mizu Shower Channel comes in a 900mm long version that will suit the short side of about 90% of showers. The removal of the choice of custom fabrication makes life easier for everyone as the cost of custom fabrication and the delays commonly experienced are best avoided.

The 'LITE' version of the Mizu Shower Channel is only 300mm long and can deliver the same effect as the larger channel at a lower cost, and with fewer issues surrounding fitment. The lower price point of this product opens up a much larger market in competition with traditional round grates. Your clients will love it. The chosen finish, which is brushed chrome over D.R brass castings, has an austere appeal very much in line with the high end consumer who will choose this type of product. A bright chrome finish is considered too "bling." Available exclusively through Reece stores nationally.

The Hybrid Puddle Flange Vinyl Floor Waste....

- Design provides more functionality at a lower price
- Available in 80mm and 100mm in pipe sizes
- Bigger flange with greater bracing effect
- Bayonet grate means no visible fixings
- Solid brass clamp ring provides best in class pull down
- Incorporates unique temporary mortar exclusion device
- Security of glued connection
- Proven anti-bacterial quality of brass

Collis Marketing • Pride Industries • Wasteland Plumbing Supplies
Midlink Plumbing Supplies • Wholesale Products • Steve Molloy Agencies

local call cost only

Call 1300 799 982

ARTPLASTICS

Temporary solution for a Permanent Problem

Colin Jay

Senior Columnist

Temporary downpipe is now available in two sizes 100mm and 150mm for larger applications such as factories. Temporary downpipe will stop splashing water turning your site into a quagmire. The increased thickness of the Art Plastics product means UV stability is the best available. Use hose clamps on the 150mm to prevent the weight of water pulling the tube off the nozzle. Remember "once you've gone black you'll never go back!"



ARTPLASTICS



ARTPLASTICS

"Advertisements contain the only truths to be relied upon in a newspaper"

Husband catches best friend on balcony naked

Tim Lucas
Chief Product Analyst

Suspicious were aroused when John Smith of Liverpool came home early to find the local plumber Joe on his tenth floor balcony, examining the 100mm floor waste that was set into an Art Plastics Puddle Bend that reduced to 50mm within the thickness of the 150mm slab. When taken to task over the matter the

Plumber admitted that he normally used only a 50mm floor grate that got clogged up easily. He also admitted that other times the water on the deck just falls over the front, causing unsightly streaks down the fascia, but hey, that's the builder's problem! It was about then John found his trusty Labrador "Jeeves" hiding under the chair in the shade.



Joe The Plumber couldn't contain his excitement when he discovered the Art Plastics Puddle Bend!



Plumber's apprentice Miss June

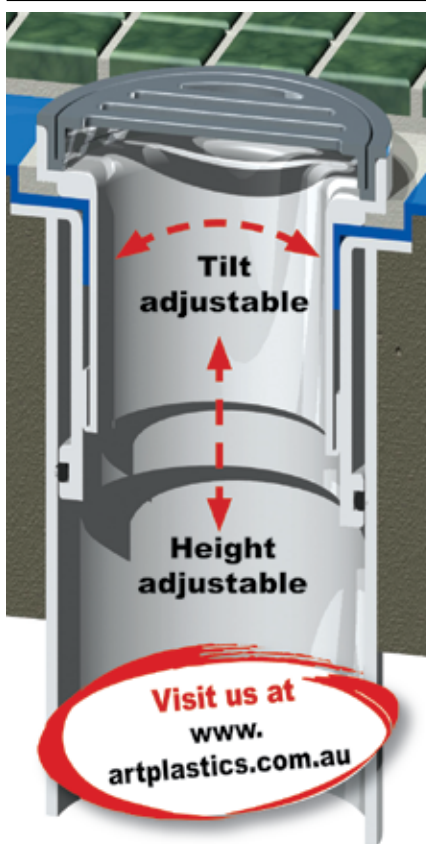

No More Chipping Concrete!

Megaflexability is what you get with wastes designed with Waterproofers and Tilers in mind!

- Art Plastics Megaflex available in 50mm, 80mm and 100mm
- Grate sits lower for easy installation
- Height adjustable top for flexibility
- Undercap tear out section stops mortar and dirt falling in
- O-ring seal allows flange to sit flat to floor
- Watermark approved
- Supplied with short patterned round or square brass grates
- Compatible with stylish Bounty Grates

50mm



80mm



100mm



Collis Marketing • Pride Industries • Wasteland Plumbing Supplies
Midlink Plumbing Supplies • Wholesale Products • Steve Molloy Agencies

local call cost only

Call 1300 799 982

ARTPLASTICS

ARTPLASTICS



ARTPLASTICS

100mm Classic Downpipe “5 degrees of separation”

Tim Lucas
Chief Product Analyst

The new Art Plastics 100mm Classic Downpipe is here. To install you simply glue the 95 degree elbows in stove pipe style over pipe. The Socket fitting provides a watertight seal suitable for charged lines. A full 5 degrees of fall avoids ponding of water in offsets that can harbour mosses. Provides greater drainage than 4x2 downpipes in skillion roofs. Watertight nozzle (gutterdrops) in 100mm are available to suit.

- New Generation “Invisible” joins give seamless look
- Efficient & Easy Installation
- Capture rainwater and still look good
- The Affordable Solution



100mm elbow



Assembled

Art Plastics Rainwater Head avoids “accidental rain bypass”

Scott Johnstone
Chief Development Engineer

The Art Plastics Rainwater Head is the original and best. Our design avoids “accidental rain bypass” sometimes encountered with sloping screens when leaves get plastered against the top screen causing precious water to get diverted out onto the ground instead of into the tank. The grille is easily removed for cleaning and stops mosses breeding in charged lines. The design is simple and functional and easy to install.

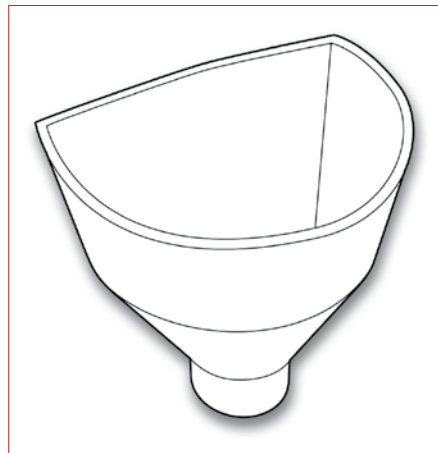

Rainwater Head

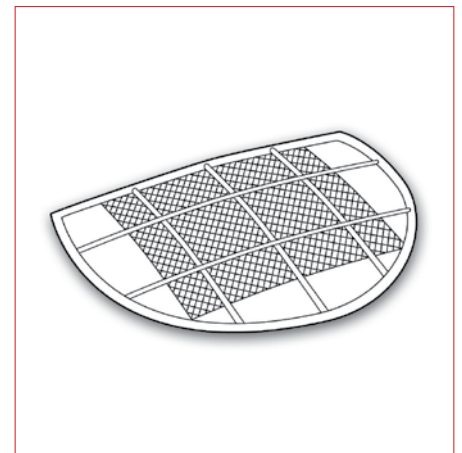

Rainwater Head Mesh

100mm Square Clearout: “it’s hip 2b²”



Colin Jay
Senior Columnist



The new 100mm square clearout from Bounty Brassware is hip to be square. Huey Lewis could have been a tiler in a previous life! Tilers love our square Bounty floor grates and now they can use the Bounty 100mm square clearout to match. Solid brass casting of the highest quality you have come to depend on.

Remember, when there is a fussy owner “Better Buy Bounty”





**“Proportion & falls are
Just Right”**

**“Gee that was
Easy to Install”**

**“Just what I wanted
Style & Quality”**

Photo of actual assembly before painting.

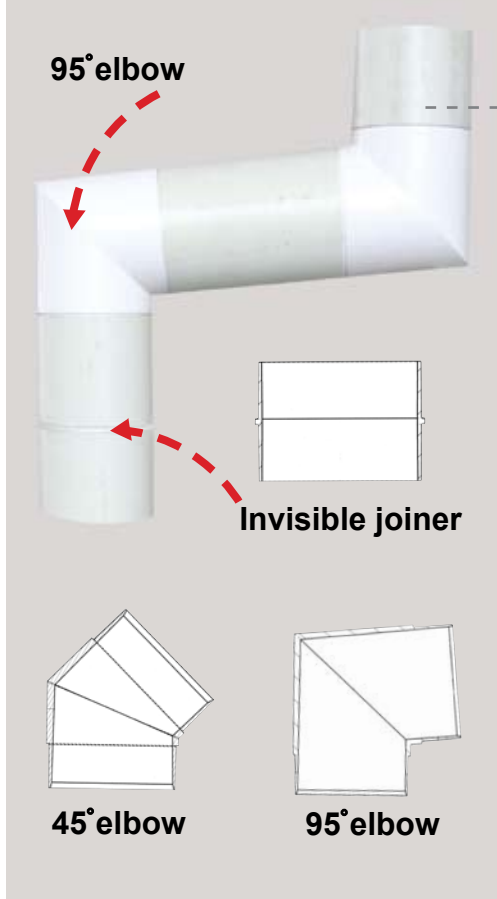

Delightful Downpipes

UPVC fittings that make installation of architectural downpipes Quick & Easy!

Your next project can now benefit from the highly visible and stylish lines of the **Art Plastics Classic Downpipe**

- **New Generation “Invisible” joins give seamless look**
- **Efficient & Easy Installation**
- **Capture rainwater and still look good**
- **The Affordable Solution**

Available Australia wide through plumbing merchants and hardware stores.

Registered designs

ARTPLASTICS

14 White Street, Bayswater WA 6053
T: 08 9370 4411 F: 08 9370 4450
enquiries@artplastics.com.au
www.artplastics.com.au

ARTPLASTICS Classified

CLASSIFIED ■ CLASSIFIED ■ CLASSIFIED ■ CLASSIFIED ■ CLASSIFIED ■ CLASSIFIED ■ CLASSIFIED ■

Plumbing Products

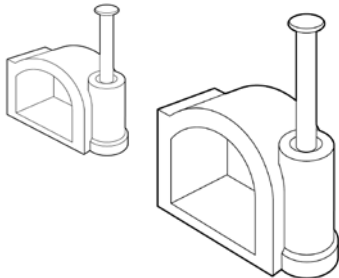

Smart Clips

For Sale, the Art Plastics range of clips are manufactured to secure PB, PEX, Copper, Lagged Copper, Gas piping, be one of the smart ones and only ask for the Art Plastics Smart Clip. **Ring 1300 799 982**

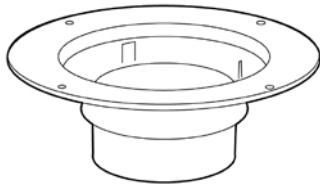

Puddle Flange

For Sale, don't be embarrassed by those wet patches use an Art Plastics Puddle Flange for all of your leak control needs. Available in 50mm, 80mm & 100mm. **Ring 1300 799 982**



Slab Repairs

For Sale, be the proud owner of one of the Art Plastics Slab Repair Adaptors, sizes available from 40mm to 150mm. Broken pipe required.

Ring 1300 799 982

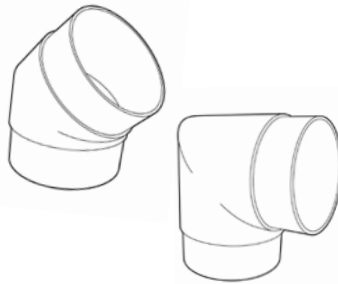

90mm Classic Downpipe

For Sale, be quick as these fittings are selling faster than downpipes are rusting. Now available in 100mm, manufactured from UV stabilized PVC, paintable.

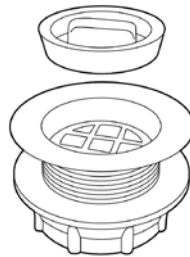

Plug & Wastes

For Sale, looking for the right Plug & Waste can be very draining. We offer one of the most comprehensive ranges of wastes in the world, take a look for yourself.

Ring 1300 799 982

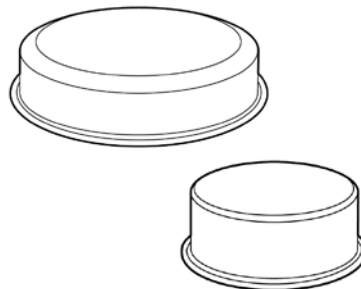

Dust Caps

For Sale, we come to you cap in hand, we want to assure you that the Art Plastics range of Dust Caps will astound you, available sizes 40mm, 50mm, 80mm, 100mm & 150mm.

Ring 1300 799 982

Vinyl Floor Wastes

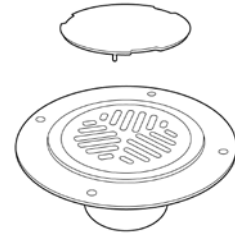

For Sale, for the best designed and manufactured Vinyl Floor Waste on today's open market (as quoted by the Daily Planet) Call the number below, you would have to be superman to find better.

Ring 1300 799 982

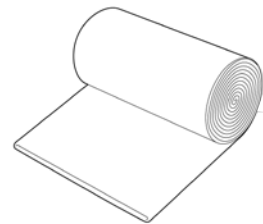

Temporary Downpipe

For Sale, prevent those premature stain marks on your rendered walls, install a Temporary Downpipe during construction. Your painter will love you for it.

Ring 1300 799 982

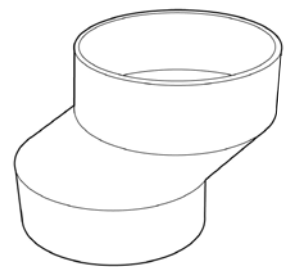

Stormwater Products

For Sale, rain or no rain we all need downpipes, using any of the Art Plastics adaptors, bends or reducers will make you feel like singing in the rain.

Ring 1300 799 982



ARTPLASTICS Classified

CLASSIFIED ■ CLASSIFIED ■ CLASSIFIED ■ CLASSIFIED ■ CLASSIFIED ■ CLASSIFIED ■ CLASSIFIED ■

Plumbing Products

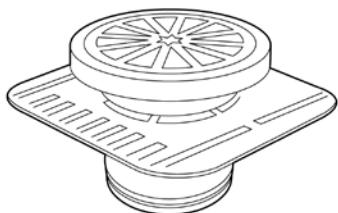

Megaflex Wastes

For Sale, don't be a drip use an Art Plastics Megaflex Waste, as your leak control device. With matching chrome on brass SQ or RND grate, available in 50mm, 80mm & 100mm

Ring 1300 799 982

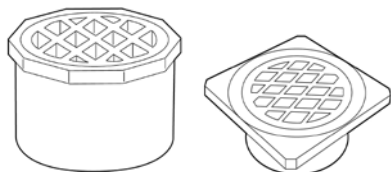

Floor Wastes

For Sale, don't "Waste" your time looking at anything but the Art Plastics range of Floor Wastes. Too many available to list visit www.artplastics.com.au to view the complete range, you will be surprised.

Ring 1300 799 982



Bermuda Wastes

For Sale, be quick before they vanish before your eyes, manufactured in solid DR brass, available in 80mm & 100mm square. Experience the phenomenon of the Bermuda.

Ring 1300 799 982



Plug & Waste Adaptors

For Sale, having a problem with length, we have the solution. Extensions available from 20mm up to 75mm. Too big, well use one of our many reducers.

Ring 1300 799 982

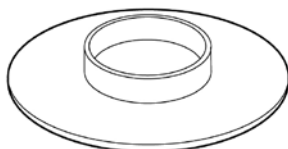

Safe Waste Trays

For Sale, feeling lonely well use one of our Safe Waste Trays for all your bonding needs (membrane that is). As well as bracing your pipes it provides an excellent surface for waterproofing.

Ring 1300 799 982

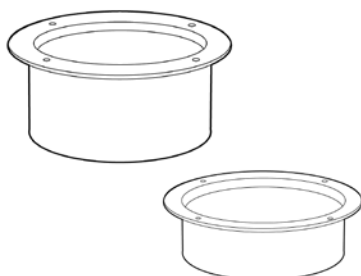

Gutter Pops

For Sale, don't pop a blood vessel when assembling your downpipes use an Art Plastics Gutter Pop, sizes available 50mm, 75mm, 90mm & 100mm. Pop into your local supplier for a look.

Ring 1300 799 982

Rain Water Products

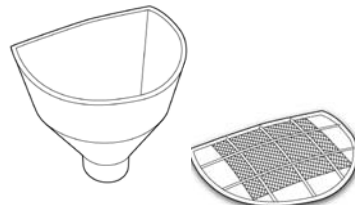

For Sale, need a good head, our Rainwater Head is the ideal rain water filtering product.

Designed to be easily removed for cleaning. Available in 90mm. It's good value for your money assured.

Ring 1300 799 982



Bounty Wastes

For Sale, you will be a wanted man when you offer your customers this very appealing range of brass floor wastes. For a comprehensive viewing visit www.artplastics.com.au.

Ring 1300 799 982

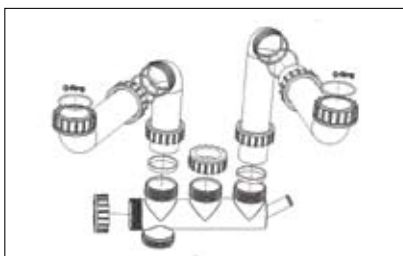

Space Maker

For Sale, need an extra room, use our new under sink Space Maker by pushing all of the waste pipe to the back of your cupboard you will create enough room for the mother in law.

Ring 1300 799 982



Distributors

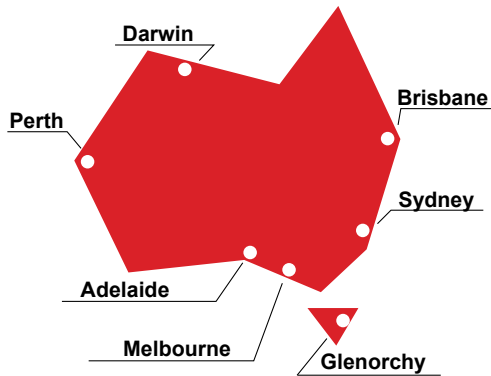

Western Australia

Pride Industries:

Bayswater WA 6053
Ph: 08 9272 6511
Fax: 08 9272 3427
Email: sales@prideindustries.com.au
Contact: Stephen Quinn
Mobile: 0438 941 309

Victoria

Midlink Plumbing Supplies:

10/477 Maroondah Hwy
Ringwood VIC 3134
Ph: 03 9879 4080
Fax: 03 9879 4048
Email: Midlink@optusnet.com.au
Contact: David Jolly
Mobile: 0414 330 915

Queensland

Collis Marketing Services:

Unit 1, 10-12 Glasson Drive
Bethania QLD 4205
Ph: 07 3805 6664
Fax: 07 3805 6668
Email: cms@collismarketing.com.au
Contact: Pat Matthews
Mobile: 0414 386 526

New South Wales

Wasteland Plumbing Supplies:

Unit 5, 11-13 Foundry Road
Seven Hills NSW 2147
Ph: 02 9674 7680
Fax: 02 9674 7681
Email: sales@wasteland.com.au
Contact: Colin Jay
Mobile: 0418 441 542

Tasmania

Wholesale Products:

4 Knoll Street
Glenorchy TAS 7010
Ph: 03 6273 3455
Fax: 03 6273 1901
Email: wholprod@iprimus.com.au
Contact: Jeff Bush
Mobile: 0409 653 722

South Australia

Steve Molloy Agencies:

18 Main Terrace
Richmond SA 5033
Ph: 08 8352 8600
Fax: 08 8352 8622
Email: stevesma@ihug.com.au
Contact: Steve Molloy

Northern Territory

Rhino Industrial :

15 Berrimah Road
Berrimah NT 0828
Ph: 08 8947 3400
Fax: 08 8947 3656
Email: rhinoindustrial@bigpond.com
Contact: Bruce Perry

The ARTPLASTICS Tribune

Advertisements contains the only truths to be relied in a newspaper.

The Art Plastics Tribune is published by Art Plastics in the interests of improving your knowledge about our products as well as entertaining you - our customers! Just as no animals have been harmed in the production of this publication, no harm is intended to any of the hypothetical characters featured. Art Plastics is a highly efficient, low cost producer of specialised and innovative plumbing products. Strategically located in Perth, the company is ideally placed to take advantage of back loading rates to all eastern destinations.

Art Plastics prides itself on providing superior products at a fair price. Our quality is unmatched and our distribution network means our customers receive products in a timely manner with local support at all times.

ARTPLASTICS

PROBLEM SOLVING PLUMBING PRODUCTS

Art Plastics, 14 White Street, Bayswater
Perth WA 6053

Phone: 08 9370 4411 Distributors: 1300 799 982
Fax: 08 9370 4450

For more information, contact:
Scott Johnstone, General Manager
Ph: 0417 949 865
scott.johnstone@artplastics.com.au

Art Plastics Sell Out Designbuild Show in 2006!

Clark Kent

Central Plumbing Agency

Art Plastics participation at Designbuild 2006 was a huge sell out success! The team worked tirelessly building relationships and peddling their wares. Here is a photo of a couple of our hardworking team members and a customer at our stand.



Howard Declares Nuclear Hot Water Systems for all Houses Obvious Solution to Global Warming!

Tim Lucas

Central Plumbing Agency

Asked which electorates he was placing them in, he said it was a clean green solution with a safer more friendly kind of nuclear energy. Mr Howard you didn't answer the question - What question? Which electorate will be the unwilling host to this reactor? All people in every electorate around the country will benefit from this far

reaching clean green policy and might I say that it will create opportunities for installers. Are you seriously proposing to place nuclear reactors in every house in Australia? No. You should have asked me where the reactor is to be sited. I did. Would you like to know? Yes please Mr Howard, I would like to know. Offshore. Oh really, like where Christmas Island or Naru? No further away. China?

No. Can you just tell us. Of course you only have to ask. Outer space. We calculate that the nuclear fission of the sun generates sufficient power to heat the water for all domestic hot water systems to make a significant impact on energy consumption even if its taking water from 10 degrees to 15 degrees - there is an energy saving being made. Is that our nuclear debate? Afraid so.

www.artplastics.com.au

"Advertisements contain the only truths to be relied upon in a newspaper"